

# ÄKTA™ pure

## CHROMATOGRAPHY SYSTEMS

ÄKTA™ pure is a flexible and intuitive chromatography system (Fig 1) for fast purification of proteins, peptides, and nucleic acids from microgram levels to tens of grams of target product. ÄKTA™ pure is a reliable system where hardware and UNICORN™ software are designed to work together with columns and chromatography resins to meet purification challenges.

We offer two versions of ÄKTA™ pure: ÄKTA™ pure 25, designed for a broad range of research applications and purification tasks in a multiuser environment; and ÄKTA™ pure 150, which is well-suited for optimizing resource utilization and productivity in routine large-scale preparative purification. The system supports a wide range of chromatography techniques and meets the automation requirements needed to deliver high purity. You can configure the system at any time with a wide range of options to further increase its capabilities depending on your purification needs.

ÄKTA™ pure is the product of over 50 years of expertise in protein research and three decades of experience in the development of ÄKTA™ purification systems.

ÄKTA™ pure provides you with the following benefits:

- Modular system design with a large range of options to allow flexibility in purification of proteins and peptides
- Intuitive and flexible method creation, system control, and evaluation with UNICORN™ software
- Practical size, for easy placement on laboratory bench or in cold cabinet
- Reliable system with components and integrated features based on the proven design of ÄKTA™ protein purification systems
- Predefined method settings for all our laboratory-scale chromatography columns



**Fig 1.** ÄKTA™ pure is a flexible chromatography system for the reliable purification of proteins, peptides, and nucleic acids at laboratory scale.

## System overview

ÄKTA™ pure chromatography system is a highly versatile, modular system with a number of design features to facilitate reliable purification.

The system consists of the ÄKTA™ pure instrument and UNICORN™ software. The system is modular in design with all valves, monitors, and columns mounted on the forward-facing wet side of the system. The design allows easy interaction with the instrument modules (Fig 2). Additional components such as valves, monitors, and sensors from the wide range of optional modules can easily be added to the available positions. Multiple rails for attachment of column holders and equipment are located at the front and on the side of the instrument. A buffer tray on the top of the instrument provides a large storage area for vessels and bottles. The instrument control panel shows the system state and allows the possibility to interact with the run (pause/continue) at the touch of a button.

(A)



- 1 **Rails** for attachment of column holders and accessories (also on the left-hand side)
- 2 Verify gradients with the **conductivity monitor**
- 3 **Round fraction collector** F9-R for collection in various tube types
- 4 **Column valve** V9-Cs with built-in bypass and reverse-flow functionality
- 5 **UV monitor** U9-L for detection at 280 nm
- 6 **Tubing organizer**
- 7 **Inlet valve** V9-IAB allows selection between two A and two B positions in a single valve
- 8 **High-performance system pumps**

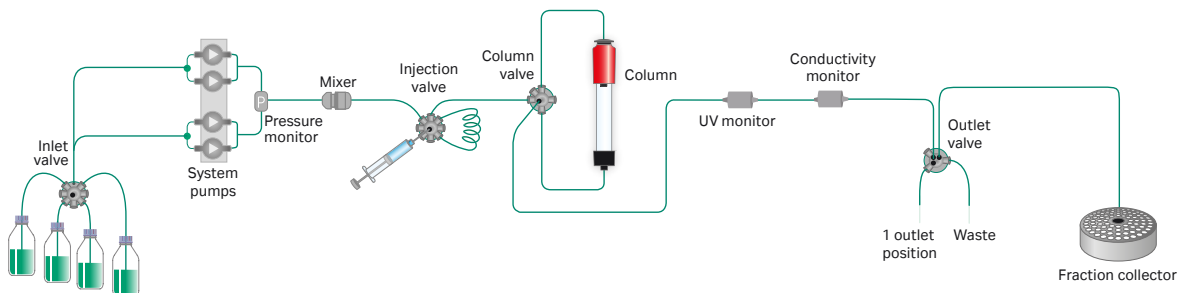

(B)



- 1 **Sample pump** S9 for automated sample loading of multiple samples
- 2 **Sample inlet valve** V9-IS for automated sample loading of multiple samples
- 3 **Flexible fraction collector** F9-C for collection in deep-well plates and/or tubes
- 4 **Column valve** V9-C and V9-C2 increase automation capabilities and resin screening for up to 10 columns. Pressure drop over the columns is measured
- 5 **UV monitor** U9-M for triple wavelength detection
- 6 **pH valve** V9-pH enables in-line pH monitoring, calibration, and storage
- 7 **Inlet automation valves** V9-IA and V9-IB gives 14 inlet positions and enables condition screening. Air sensors are integrated to protect the columns
- 8 Position for additional modules

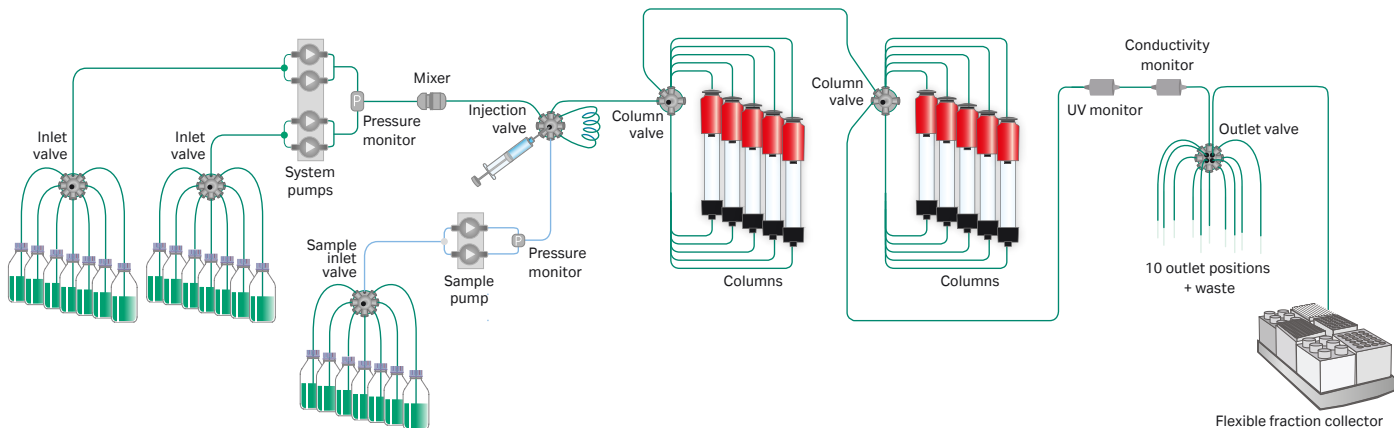

**Fig 2.** Two examples of system configurations for ÄKTA™ pure showing positions of modules on the front panel and flow paths for each. (A) A basic system configuration for convenient protein purification; (B) System configured for high level of automation.

The system weighs 48 kg in basic configuration and 53 kg when fully equipped with options. The relatively low weight enables easier placement in the laboratory. The system dimensions allow it to fit conveniently into a standard cold cabinet for work with labile samples.

Regardless of configuration, ÄKTA™ pure always comes with two high-performance system pumps, system pressure monitor for column protection, mixer, injection valve, and UV monitor. ÄKTA™ pure has a wide range of optional modules to allow a large number of possibilities. The system flow path is designed to minimize band-broadening effects, and all wetted materials used in the flow path are biocompatible and resistant to commonly used solvents. The instrument front is designed with empty module positions where optional valves and monitors can be mounted to enable a flexible configuration of the flow path. Examples of two ÄKTA™ pure system configurations are shown in Figure 2.

UNICORN™ software allows a fast and easy start to creating methods, controlling runs, and evaluating results. UNICORN™ software eliminates the need for programming skills as creation of chromatography methods is done by simple drag-and-drop operations. In addition, the software is modular allowing the addition of features such as Column Logbook and Design of Experiments (DoE) functionality for method development. Licensing options for remote access to the system and/or for creating methods or evaluating results give even greater convenience. If preferred, the system can be set up so that it enters “power save mode” after method end, which enables reduction of power consumption by around 80%.

ÄKTA™ pure system components and available options are described in the following sections in more detail.

## ÄKTA™ pure standard components

### System pump

The two system pumps are based on the technology developed for ÄKTA™ avant systems. The robust construction delivers reproducible flow rates at both low and high back pressures, allowing short separation times.

Each pump consists of one pair of pump heads, which deliver low-pulsation flow to the mixer. The continuous and accurate flow rates generated enable reproducible isocratic or gradient elution. For ÄKTA™ pure 25 and ÄKTA™ pure micro, the system pumps provide a flow rate range of up to 25 mL/min at maximum operating pressure of 200 bar (2900 psi, 20 MPa). For ÄKTA™ pure 150 the flow rate is up to 150 mL/min at maximum operating pressure of 50 bar (725 psi, 5 MPa). For column packing, ÄKTA™ pure 25 and 150 can be used at flow rates up to 50 mL/min and 300 mL/min, respectively. A system pressure monitor is connected to the pumps to continuously measure system pressure and enable flow rate to be automatically adjusted to avoid reaching any defined pressure limit.

### Mixer

The mixer enables homogeneous buffer composition during gradient runs. The choice of mixer chamber size depends on the flow rate and buffers used. A larger mixer volume is required for higher flow rates or difficult-to-mix buffers. Table 1 shows the mixer chamber sizes available for each instrument.

An in-line filter is mounted inside the mixer. The filter and the mixer are changed by snapping the mixer in or out of the mixer holder. The mixer size used for any given run is always noted in the result file.

**Table 1.** Available mixer chamber sizes

System	Mixer chamber sizes
ÄKTA™ pure 25	Included: 1.4 mL; options: 0.6 and 5 mL
ÄKTA™ pure 150	Included: 1.4 and 5 mL; option: 15 mL
ÄKTA™ pure micro	Included: 0.6 mL

### Injection valve

The injection valve V9-Inj used in ÄKTA™ pure 25 and ÄKTA™ pure 150 allows for different sample application techniques:

- Sample loops or Superloop™ filled manually via a syringe
- Sample loops or Superloop™ filled using an optional sample pump
- Sample applied directly to the column using an optional sample pump

The valve design eliminates the need for replumbing when changing between various sample application techniques. A sample loop with a volume of 500 µL is delivered with the ÄKTA™ pure system.

The injection valve V9M-J, used in ÄKTA™ pure micro, is optimized for small sample volumes in microliter scale and allows for Sample loops to be filled manually via a syringe. Sample loops with a volume of 10 µL and 50 µL are delivered with the ÄKTA™ pure micro system.

### UV monitoring

ÄKTA™ pure is equipped with either a fixed wavelength UV monitor or a variable multiwavelength UV and visible spectrum monitor.

The fixed wavelength (280 nm) UV monitor U9-L incorporates LED technology, which is durable, reliable, and ready to use at start-up. The design of the UV monitor U9-L prevents heating of the sample. The monitor is available with a 2 mm flow cell as standard (included at delivery) and an optional 5 mm flow cell when higher sensitivity measurements are required. For the U9-L monitor, the lamp operating time is at least 10 000 h.

UV monitor U9-M is designed for multiwavelength detection in the UV and visible spectrum from 190 to 700 nm. UV monitor U9-M allows monitoring of up to three wavelengths simultaneously (Fig 3 and 6). For optimized performance when purifying samples with different protein concentrations, there are three flow cell path lengths available; 0.5, 2 (included at delivery), and 10 mm. ÄKTA™ pure micro is equipped with the U9-M monitor and is delivered with a 2 mm cell with a smaller internal volume. The flow cell design, together with fiber optic technology, provides a high signal-to-noise ratio without causing any local heating of the UV flow cell. The monitor contains a high-intensity xenon lamp with an operating time of at least 5000 h and that requires minimal start-up time. Every time the instrument is switched on, the monitor is automatically calibrated. All U9-M UV cells are calibrated at manufacturing. The UV signal is automatically normalized making it possible to compare UV data from different systems.

Monitoring with multiple wavelengths can be used to detect contaminants, specifically labeled proteins, or target molecules that do not absorb light at 280 nm. Figure 3 shows results that demonstrate the possibilities when monitoring with multiple wavelengths. Molecular weight standards were monitored at 214, 280, and 340 nm wavelengths. Detection at 214 nm reveals peptide bonds of all proteins and can be useful if the concentration and extinction coefficient at 280 nm is low for the target protein. Ferritin, a multimeric iron-storage protein, showed stronger absorbance at 340 nm than the other proteins due to the high number of ferric ions in the center of the molecule.

Column: Superdex™ 200 10/300 GL  
 Sample: Molecular weight standards for size exclusion chromatography  
 Sample volume: 100 µL  
 Eluent: PBS (10 mM sodium phosphate, 140 mM NaCl, 2.7 mM KCl, pH 7.4)  
 Flow rate: 0.5 mL/min  
 System: ÄKTA™ pure 25

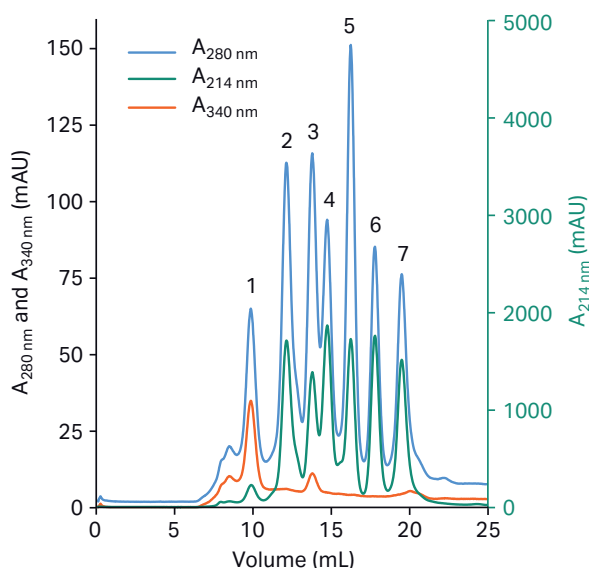

**Fig 3.** Size exclusion chromatography (SEC, also known as gel filtration) with multiwavelength detection (214, 280, and 340 nm) of proteins using ÄKTA™ pure with UV monitor U9-M. The column used was Superdex™ 200 10/300 GL. The peaks observed on the chromatogram are (1) ferritin (M<sub>r</sub> 440 000), (2) aldolase (M<sub>r</sub> 158 000), (3) conalbumin (M<sub>r</sub> 75 000), (4) ovalbumin (M<sub>r</sub> 44 000), (5) carbonic anhydrase (M<sub>r</sub> 29 000), (6) ribonuclease A (M<sub>r</sub> 13 700), and (7) aprotinin (M<sub>r</sub> 6500).

Both UV monitor U9-L and UV monitor U9-M can be combined with a second UV monitor U9-L to give increased application capabilities such as multistep applications or when using small and large flow cells simultaneously to detect both low and high protein concentrations.

### Conductivity monitor

The conductivity monitor measures conductivity of buffer and samples for online monitoring of the true gradient. An integrated temperature sensor corrects for variations in conductivity due to the temperature. The conductivity monitor has a broad reading range and is therefore able to monitor conductivity in different chromatographic techniques.

## ÄKTA™ pure optional modules for enhanced automation

### Sample application options

The optional sample pump (Fig 4) is designed to allow automatic sample application directly to a column or indirectly via a sample loop or Superdex™ unit. Using the sample pump saves time by eliminating laborious sample application steps and is especially useful when handling large sample volumes. The pump consists of two pump heads and is based on the same pump principle as the system pumps. Pump purging and air removal can easily be performed automatically. The sample pump is equipped with a pressure sensor for control of the sample flow rate to protect the column while preventing pressure stops and minimizing the time for sample loading. Using the sample pump, samples can be loaded at flow rates of up to 50 mL/min (Sample pump S9) or up to 150 mL/min (Sample pump S9H).

The optional sample inlet valve, V9-IS or V9H-IS, is intended to be used with the sample pump. Inlet valve allows fast, automatic loading of up to seven different samples. The integrated air sensor enables complete sample application without the need to preprogram the sample volume. The valve has seven sample inlet positions plus a dedicated buffer inlet for filling the sample pump with solution before the sample is introduced and for washing out the valve and pump between runs. During sample application, the air sensor detects when sample has been completely loaded so that the method can continue to the next step without air being introduced into the flow path or column.



**Fig 4.** ÄKTA™ pure sample pump.

### Buffer selection

ÄKTA™ pure can be equipped with two different types of inlet valves that allow selection of buffers and wash solutions. Valves with multiple inlets enable cleaning reagents to be permanently on-line, which means that columns and system can be cleaned conveniently at regular intervals.

Inlet selection valve, V9-IAB or V9H-IAB, comprises two A and two B inlet positions in a single valve offering a convenient solution for automation of buffer application and post-run cleaning of columns and system when performing basic chromatography. Any A inlet can be combined with any B inlet to generate gradients. The inlet automation valves A and B provide up to 2 × 7 inlets. Multiple inlets enable automatic screening of buffer and reagent conditions. Each of the inlet automation valves is equipped with an integrated air sensor, which helps in excluding air from the system. If air is detected, the system can be paused so that the air can be removed before it enters the flow path.

## Column control

Column valves can be connected to the system and used to control the flow to the column. ÄKTA™ pure can be equipped with different column valves.

Column control valve, V9-Cs or V9H-Cs, allows connection of one column and has an integrated bypass function, which enables washing of the system without the need to remove the column. The column control valve also allows reverse flow through the column, for fast and effective elution of strongly bound proteins, sharper bands, and a concentrated target molecule eluent.

Column selection valves, V9-C/V9-C2 or V9H-C/V9H-C2, also have the integrated bypass and reverse-flow functions. One or two column selection valves may be connected to the system enabling connection of up to 10 columns for automatic column switching. Connection of multiple columns minimizes manual intervention and reduces further the risk of introducing air into the column.

The column selection valve has two integrated pressure sensors: the first sensor measures pressure before the column, enabling protection of the column hardware while the second measures the pressure after the column. The pressure drop over the column ( $\Delta p$ ) is calculated by measuring the difference between the two pressure readings and can be used to protect the packed resin bed (Fig 5).

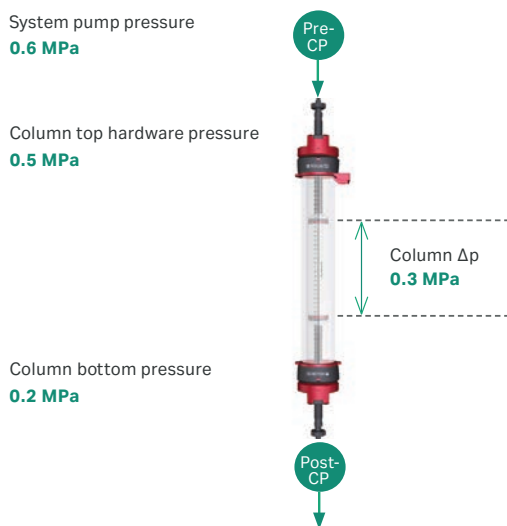
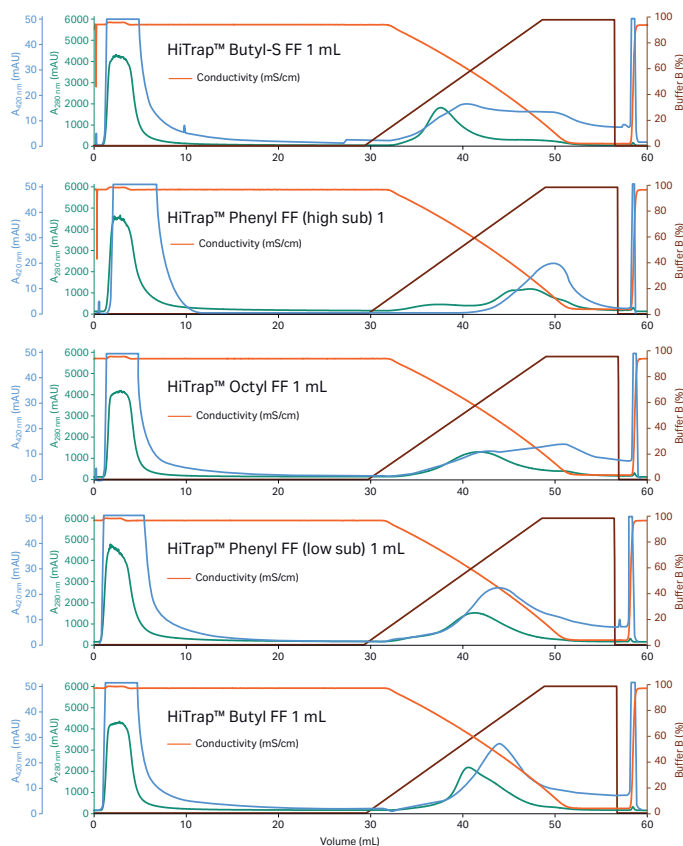

**Fig 5.** For increased operational safety, the column selection valve enables continuous measurement of precolumn (Pre-CP) and post-column pressure (Post-CP) during runs. The pressure difference over the packed resin bed ( $\Delta p$ ) is calculated from the two signals.

The flexibility of the column selection valve for connection of up to five columns per valve was demonstrated in a column scouting study using columns for hydrophobic interaction chromatography (HIC). Five columns from HiTrap™ HIC Selection Kit were connected to ÄKTA™ pure and used for column scouting for optimization of purification conditions of S-aminotransaminase in clarified *E. coli* extract. UV monitor U9-M was used for detection of the protein at two wavelengths. Chromatograms of the five separate HIC runs are shown in Figure 6. Eluted fractions were analyzed using SEC and SDS-PAGE (data not shown).

The  $A_{420}$  signal specifically monitors the target protein. The columns giving the sharpest and most symmetrical peaks at  $A_{420}$ , as well as the highest possible purity, were selected for subsequent optimization and scale-up experiments. HiTrap™ Phenyl FF (high sub) 1 mL and HiTrap™ Butyl FF 1 mL gave the most promising results under the conditions used, and HiTrap™ Phenyl FF (high sub) 1 mL was selected for further optimization in this case.

**Columns:** Five columns from HiTrap™ HIC Selection Kit  
**Sample:** Supernatant after precipitation with 2 M ammonium sulfate (AS) at room temperature of extract of *E. coli* expressing S-aminotransaminase (adjusted to 1.5 M AS)  
**Sample volume:** 2 mL  
**Buffer A:** 1.5 M ammonium sulfate, 50 mM sodium phosphate, pH 7.0  
**Buffer B:** 50 mM sodium phosphate, pH 7.0  
**Flow rate:** 1 mL/min  
**UV cell:** 10 mm  
**System:** ÄKTA™ pure 25 equipped with Column selection valve V9-C and Loop valve V9-L



**Fig 6.** Column scouting for purification of S-aminotransaminase expressed in *E. coli*. Column selection valve V9-C allowed the connection of five HiTrap™ HIC columns to ÄKTA™ pure for this evaluation. UV monitor U9-M was used for multiwavelength detection. From this scouting, HiTrap™ Phenyl FF (high sub) 1 mL was selected for use in further scale-up studies.

## pH monitoring

An optional pH valve with an integrated pH electrode (not included) enables in-line pH monitoring during the run. The pH monitor is easily calibrated by injection of calibration buffer directly into the valve with the pH electrode mounted. A flow restrictor is connected to the pH valve and can be automatically included in the flow path to generate a back pressure that prevents the formation of air bubbles in the UV flow cell. The pH valve is used to direct the flow to the pH electrode and flow restrictor, or alternatively, to bypass one or both. Bypassing the pH electrode means that it can be stored and kept in place on the valve at all times.

## Outlet valves

Two different valve options are available to direct the flow to the fraction collector, waste, or other outlet ports. Outlet control valve, V9-Os or V9H-Os, allows connection of one or two fraction collectors. If only one is connected, the other port can be used for outlet fractionation, for example to collect flowthrough. The outlet valve V9M-Os, used in ÄKTA™ pure micro, offers the same functionality as V9-Os but with smaller internal volume. Outlet fractionation valve, V9-O or V9H-O, enables connection of up to two fraction collectors, and up to 10 available outlets allow collection of large fractions.

## Fraction collection

ÄKTA™ pure can be equipped with the round fraction collector F9-R (Fig 7), the dual-plate fraction collector F9-T (Fig 8), or the flexible fraction collector F9-C (Fig 9). For reversed phase chromatography applications, use Fraction collector F9-R or F9-T. All three fraction collectors are controlled through UNICORN™ software. Fraction collection can be based on time, volume, or automatic peak recognition. Automatic peak recognition minimizes cross-contamination and unwanted eluent can be diverted to the waste. For increased capacity, two units of fraction collector F9-R, one F9-T and one F9-R, or one F9-R and one F9-C can be connected together.



**Fig 7.** Fraction collector F9-R allows collection in 3, 8, 15, or 50 mL tubes.

Fraction collector F9-R provides a basic option with high capacity. A variety of racks is available to allow the use of 3, 8, 15, and 50 mL tubes. You can use tube holders to support the use of Eppendorf™ tubes. To minimize spillage, the DropSync function can be used for flow rates up to 2 mL/min. DropSync minimizes spillage by timing fraction changes between drops.



**Fig 8.** Fraction collector F9-T allows for collection in various deep-well plate formats (24-, 48-, and 96-well), 96-well microplates, or tubes (0.5, 1.5, 2 mL and 50 mL).

Fraction collector F9-T offers a small footprint and enables fraction collection in various deep-well plate formats (24-, 48-, and 96-well), 96-well microplates, or tubes (0.5, 1.5, 2 mL and 50 mL). To minimize spillage, the DropSync function can be used for flow rates up to 5 mL/min. You can load two racks (deep-well plates, microplates, or small tubes) into the fraction collector together with one holder for four 50 mL tubes. The graphical interface in UNICORN™ software makes it easy to control the fractionation.

Fraction collector F9-C provides flexibility, high capacity, and security. The fraction collector is equipped with a variety of cassettes that can hold tubes (3, 8, 15, and 50 mL) as well as deep well plates (24-, 48-, and 96-well), which means that samples can be collected in any format needed. Six cassettes can be loaded into the fraction collector in any combination that fits the user's needs (Fig 8). As an alternative to using six cassettes, loading capacity can be maximized by using a large tube rack for 50 mL tubes or a bottle rack for 250 mL bottles. Upon loading, the type of cassette is automatically detected by a sensor and the tube/bottle configuration is confirmed, eliminating mistakes in sample handling. Cassettes designed for tubes are equipped with a function that locks tubes into place when discarding liquid waste. Later, the tubes can be easily unlocked and discarded.

The cassettes can also be used for convenient storage of fractions or holders for sample tubes and are easy to handle and clean. The fraction collector is covered, protecting samples from dust contamination. The top of the fraction collector can be used for placement of accessories and equipment.

Fraction collector F9-C has two beneficial features that minimize cross-contamination and spillage during fraction collection. DropSync can be used for flow rates up to 2 mL/min and minimizes spillage by timing fraction changes to occur between drops. At higher flow rates, the accumulator function provides spillage-free fractionation without sample-loss up to 150 mL/min. The system can automatically change between the two modes for optimal performance.



**Fig 9.** Fraction collector F9-C holds cassettes for a variety of tubes from 3 to 50 mL as well as 24-, 48-, and 96-deep-well plates.

## Additional module options

ÄKTA™ pure is a fully modular system that can be further expanded to increase system capability and productivity. Due to the accessibility and design of the modules, they are easily changed, which allows quick and efficient customization.

Versatile valve, V9-V or V9H-V, is a general four-position valve that can be used to tailor the system to specific tasks, for example, for multistep purification schemes. For more information about automated multistep purification, visit [cytiva.com/PureAutomation](http://cytiva.com/PureAutomation).

Up to four versatile valves can be connected to the system. Mixer bypass valve, V9-M or V9H-M, is used for bypassing the mixer if samples are loaded through the system pump. Loop valve, V9-L or V9H-L, allows the use of up to five loops and can be used for collection of intermediate fractions when performing multistep purification or for automated purification of up to five different samples. The loop valve can, for example, also be used for holding reagents or different samples.

Up to two extra eight-position inlet valves can be deployed to expand on buffer and sample inlet capacity. Up to four additional air sensors can be placed in the flow path to enhance security, for example, before the inlet valves or before the column.

I/O-box E9 provides a means of connecting external interfacing equipment such as detectors. I/O-box E9 receives analog or digital signals from, or transfers analog or digital signals to external equipment that needs to be incorporated in the system. Two I/O-box E9 units can be connected to ÄKTA™ pure.

A list of available additional valves and other options is found in *Ordering information*.

## ÄKTA™ pure micro and Micro kit for purification in microliter scale

The ÄKTA™ pure micro enables a flow path with low hold-up volumes and provides a complete solution for small sample volumes and micro preparative columns. The system is equipped with 0.6 mL mixer, injection valve, 2 mm UV flow cell, conductivity monitor, and outlet valve. Together with appropriate tubing and connectors the system volumes are minimized, and high peak resolution is maintained throughout the flow path. The included injection fill port enhances accuracy when users inject small sample volumes with the 10 and 50 µL sample loops. The multidirectional column clamp provided allows attachment of the column directly to the UV monitor.

Scientists use the Micro kit to convert the ÄKTA™ pure 25 M flow path for well optimized microscale purification, and includes the same components and tubing as used in ÄKTA™ pure micro.

To collect fractions, we recommend the fraction collector F9-T. Optionally, you can use the fraction collector F9-R. The Micro kit includes a micro fractionation nozzle for F9-R for small droplets, and tube holders for Eppendorf™ tubes.

## UNICORN™ software

UNICORN™ software gives you real-time control of your chromatography system. UNICORN™ consists of four modules: **Administration**, **Method Editor**, **System Control**, and **Evaluation**. This section describes some of the valuable tools included in UNICORN™ for increasing operational security, efficiency, and productivity.

### Method Editor

The **Method Editor** module allows you to create or adjust methods to suit your application needs. It contains all the instructions used for controlling the run. The **Method Editor** includes built-in application support for chromatography runs. The interface provides easy viewing and editing of the run parameters. Figure 10 shows a screenshot of the **Method Editor** with customizable panes that provide a comprehensive overview of the run.

The **Method Editor** provides a choice of predefined methods for different chromatography techniques and maintenance procedures. Methods are built using phases. Each phase reflects a step in the run, such as sample application or wash. UNICORN™ includes a library of predefined phases for creating or editing your own methods. A method is created or edited by dragging-and-dropping phases from the **Phase Library** to the **Method Outline**.

UNICORN™ includes a library of predefined Cytiva columns. By selecting the column in the **Phase Properties** pane, column parameters (e.g., flow rate and pressure limits) are automatically programmed into the method. For added flexibility, advanced users can edit programming instructions directly in the **Text Instructions** pane.

- 1 **Phase Library**
- 2 **Phase Properties** pane and **Text Instructions** pane
- 3 **Method Outline**
- 4 **Gradient** pane

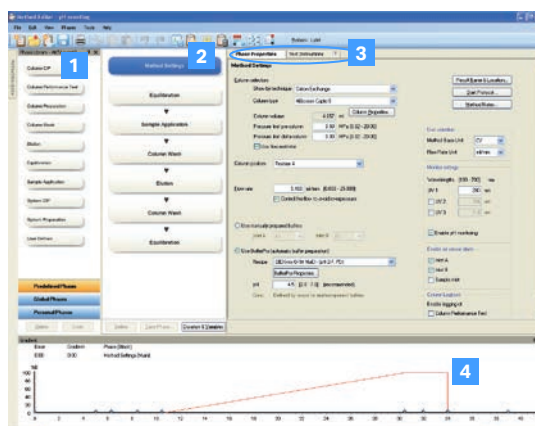

**Fig 10.** **Method Editor** has customizable panes that give a comprehensive overview of the method.

## System Control

The **System Control** module is used to start, view, and control a method run. The module consists of three panes that provide an overview of the status of the run. The **Run Data** pane presents current data in numerical values, while the **Chromatogram** pane illustrates data as curves during the entire method run.

The **Process Picture** pane displays the current flow path during the run and can be used to control the run (Fig 11). Color indication incorporated in the process picture shows the current open flow path with flow, closed flow path, or open flow path without flow. Real-time data from monitors are also displayed in the process picture pane.

## Column Logbook

To increase operational safety, an optional feature of the software is the **Column Logbook**. The practical tool keeps track of important run data related to individual columns to provide traceability and operational security. Many prepacked columns from Cytiva are barcode-labeled, and individual columns are identified using a 2D barcode scanner, or the information may be entered manually into UNICORN™. UniTag sticker labels, with preprinted barcodes, are available for other columns (e.g., empty columns). By tracking individual columns, information regarding run data such as total number of runs and maximum pressures is recorded for each run. Notification limits can be set, for instance, to define the number of times the column may be run between cleanings, and the user is notified when it is time for column maintenance. The **Column History** function provides a list of all runs that have been performed with a particular column.

In addition to **Column Logbook**, UNICORN™ offers security by utilizing electronic signatures, password protection, and audit trails. UNICORN™ is suitable for use in a regulated environment in a manner complying with FDA 21 CFR Part 11. For more detailed information, see UNICORN™ software data file (29135786).

## Design of experiments

UNICORN™ software has an integrated **design of experiments** (DoE) functionality, which can be added as an option. The **DoE** function is a powerful tool for an efficient approach to method optimization. DoE provides an efficient and structured approach where selected parameters are varied simultaneously so that a large data set can be obtained from few experiments (Fig 12). As the **DoE** tool is integrated seamlessly in the UNICORN™ software, scouting methods are automatically generated from DoE schemes, allowing fast and efficient method optimization.

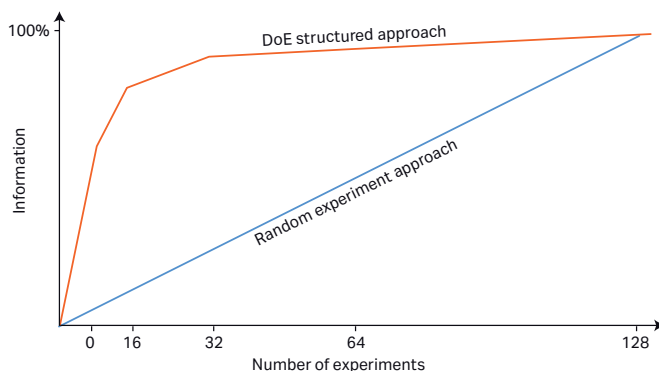

**Fig 12.** The UNICORN™ **DoE** tool is an efficient approach to optimization, capturing more information in fewer experiments.

## Evaluation

With UNICORN™ 7, the **Evaluation** module provides a simplified user interface optimized for most commonly used workflows like quick evaluation, comparison of results, and work with peaks and fractions.

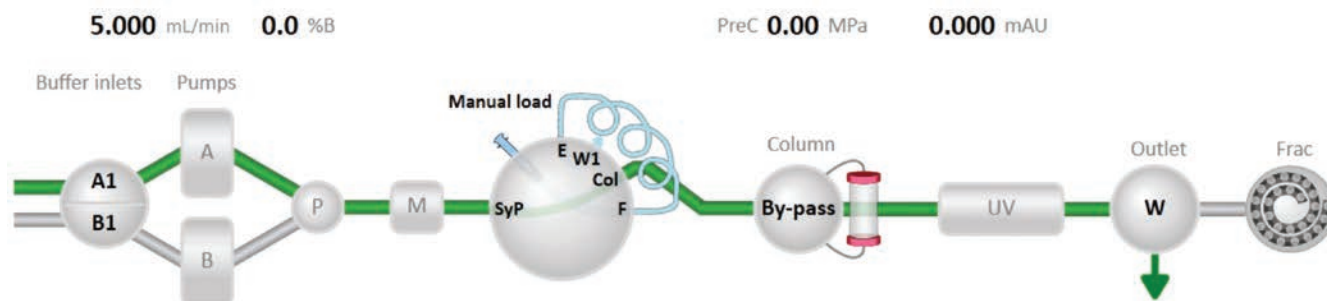

**Fig 11.** The UNICORN™ process picture shows currently active and inactive flow paths, and provides a fast and easy way to control the system.



## Accessories

ÄKTA™ pure accessories include column holders and clamps for attaching columns, flasks, and tubing to the system (Fig 13). A selection of tubing kits allow optimization of the flow path for various objectives and connection of any laboratory-scale column from Cytiva.



- 1 Flexible column holder for HiScreen™ columns
- 2 Column holder rod
- 3 Bottle and airsenser holder\*
- 4 Tubing holder, spool
- 5 Tubing holder, comb
- 6 Column and bottle holder, o.d. 10-50 mm
- 7 Column clamp, o.d. 10-21 mm
- 8 Loop holder for five 10 mL loops
- 9 Multipurpose holder†
- 10 Rail extension
- 11 Multidirectional column clamp

**Fig 13.** ÄKTA™ pure accessories include holders and clamps for attaching columns, flasks, and tubing to the system. o.d. = outer diameter.

\* To use as an air sensor holder, the adapter 28-9563-42 is also needed

† To be used to attach, for example, fraction collector cassettes on the side of the system

## Prepacked columns complete the package

Cytiva offers an extensive range of prepacked columns for purification, from microgram levels to hundreds of milligrams of target protein and for almost every chromatography technique (Fig 14). The range includes HiTrap™, HiPrep™, HiScreen™, and HiLoad™ columns for preparative chromatography. Tricorn™ columns are also available for high-resolution semipreparative purifications at microgram scale as well as for protein characterization. In addition to prepacked columns, empty columns for packing with chromatography resins of your choice are available.

### Columns for microgram-scale characterization

Tricorn™ GL and PE columns are high-performance columns prepacked with resins for a variety of chromatography techniques (Fig 13). The column design allows even distribution of liquid eluent over the entire column cross-section, which enables high-resolution purification at micro- and milligram scale. Tricorn™ GL columns are manufactured in glass to facilitate visual inspection of the resin bed while the tube and filter of PE columns are designed to withstand greater pressure.

### Columns for milligram-scale purification

HiTrap™ 1 and 5 mL columns are prepacked with a wide range of resins for purification using various chromatography techniques (Fig 14). The columns can be connected in series for greater capacity. Further scale-up can be achieved with HiPrep™ 20 mL columns.

RESOURCE™ columns are designed for high-resolution purification of proteins at high flow rates. The columns are prepacked with SOURCE™ resins that have high particle size uniformity and stability to allow high flow rates at low back pressure.

HiScreen™ columns are prepacked with a wide range of robust BioProcess™ resins to allow repeated use with highly reproducible results. Designed for scalable method optimization, HiScreen™ columns have a 10 cm bed height and can easily be connected in series to achieve a 20 cm bed height.

HiLoad™ columns are prepacked glass columns with Superdex™ prep grade resins designed for high-resolution GF applications.

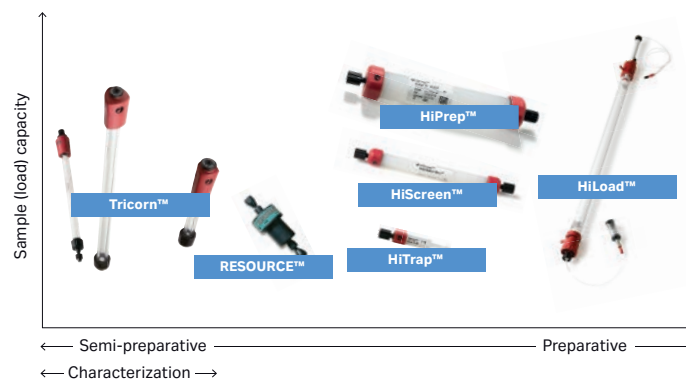

Tricorn™	High quality and high resolution (SEC, IEX, HIC)
RESOURCE™	Fast purifications with good resolution (IEX, HIC, RPC)
HiTrap™	Easy to use for a broad range of applications (AC, DS, IEX, HIC)
HiScreen™	Optimized for method and process development (AC, IEX, HIC)
HiPrep™	Fast and easy scale-up (AC, DS, SEC, IEX, HIC)
HiLoad™	Preparative SEC with high resolution

**Fig 14.** Columns for use with ÄKTA™ pure system for different scales of purification. AC = affinity chromatography, DS = desalting, SEC = size exclusion chromatography, IEX = ion-exchange chromatography, HIC = hydrophobic interaction chromatography, RPC = reversed-phase chromatography.

## Pack your own columns for gram-scale purification

The column packing instruction in ÄKTA™ pure enables convenient column packing at constant pressure and high flow rates. Both A and B pumps are used to generate the flow, making it possible to set flow rate up to 50 mL/min and 300 mL/min for ÄKTA™ pure 25 and ÄKTA™ pure 150, respectively.

Several empty column types are available. Which empty column that is best suited will depend upon resin type and running conditions (i.e., flow, pressure, etc). HiScale™ empty columns are developed for standard liquid chromatography, optimized for process development and preparative protein purification. The columns are designed to withstand high pressures and high flow rates making them compatible with BioProcess™ chromatography resins such as MabSelect™ and Capto™ resins.

XK columns are user-friendly and robust columns for standard protein purification. The columns are designed for liquid chromatography at low to medium pressure.

## System specifications

Control system	UNICORN™, version 7.6 or later
Dimensions (W × H × D)	535 × 630 × 470 mm
Weight (excluding computer, sample pump, fraction collector)	Up to 53 kg
Power supply	100–240 V, ~50–60 Hz
Power consumption	300 VA (typical), 25 VA (power-save)
Enclosure protective class	IP 21

### System pump

Pump type	Piston pump, metering type
Flow rate setting	ÄKTA™ pure 25 and ÄKTA™ pure micro: 0.001 to 25 mL/min (up to 50 mL/min during column packing) ÄKTA™ pure 150: 0.01 to 150 mL/min (up to 300 mL/min during column packing)
Flow rate specifications	ÄKTA™ pure 25 and ÄKTA™ pure micro: Accuracy: ± 1.2% Precision: RSD < 0.5% (conditions: 0.25 to 25 mL/min, < 3 MPa, 0.8 to 2 cP) ÄKTA™ pure 150: Accuracy: ± 1.5% Precision: RSD < 0.5% (conditions: 1.0 to 150 mL/min, < 3 MPa, 0.8 to 2 cP)
Pressure range	ÄKTA™ pure 25 and ÄKTA™ pure micro: 0 to 20 MPa ÄKTA™ pure 150: 0 to 5 MPa
Viscosity range	ÄKTA™ pure 25 and ÄKTA™ pure micro: 0.35 to 10 cP (5 cP above 12.5 mL/min) ÄKTA™ pure 150: 0.35 to 5 cP

### Sample pump

Pump type	Piston pump, metering type
Dimensions (W × H × D)	215 × 210 × 370 mm
Weight	11 kg
Flow rate setting	ÄKTA™ pure 25: 0.001 to 50 mL/min ÄKTA™ pure 150: 0.01 to 150 mL/min
Flow rate specifications	ÄKTA™ pure 25: Accuracy: ± 2% Precision: RSD < 0.5% (conditions: 0.25 to 50 mL/min, < 3 MPa, 0.8 to 3 cP) ÄKTA™ pure 150: Accuracy: ± 2% Precision: RSD < 0.5% (conditions: 1.0 to 150 mL/min, < 3 MPa, 0.8 to 3 cP)
Pressure range	ÄKTA™ pure 25: 0 to 10 MPa ÄKTA™ pure 150: 0 to 5 MPa
Viscosity range	0.7 to 10 cP

### Mixer

Mixing principle	Chamber with a magnetic stirrer
Mixer volume	ÄKTA™ pure 25: 0.6, 1.4 (mounted on system), or 5 mL ÄKTA™ pure 150: 1.4 (mounted on system), 5 mL (included with system), or 15 mL ÄKTA™ pure micro: 0.6 mL (mounted on system)
Gradient flow rate range	ÄKTA™ pure 25: 0.1 to 25 mL/min ÄKTA™ pure 150: 0.5 to 150 mL/min ÄKTA™ pure micro: 0.25 to 2 mL/min with 0.6 mL mixer 0.05 to 0.25 mL/min without mixer
Gradient composition accuracy	ÄKTA™ pure 25: ± 0.6% (conditions: 5 to 95% B, 0.6 to 25 mL/min, 0.2 to 2 MPa, 0.8 to 2 cP) ÄKTA™ pure 150: ± 0.8% (conditions: 5 to 95% B, 2 to 150 mL/min, 0.2 to 2 MPa, 0.8 to 2 cP)
Gradient linearity range	ÄKTA™ pure micro: 5 to 90% B at flow rates 0.25 to 2 mL/min with mixer 0.6 mL 10 to 90% B at flow rates 0.05 mL/min without mixer

### Valves

Type	Rotary valves
Number of valves	Up to 12
Functions	Standard: injection valve Options: inlet selection, mixer by-pass, loop selection, column selection, pH, outlet, versatile
Optional valves*	Up to three additional modules can be installed outside the systems chassis.

\* Using Extension boxes (Product code 29110806), up to three additional modules can be installed outside the systems chassis.

### Pressure sensors

Placement of sensors	Standard: after system pump Options: after sample pump, pre-column, post-column
Range	0 to 20 MPa
Accuracy	± 0.02 MPa or ± 2%, whichever is greater

## Module options

### Inlet valves

Inlet A	1, 2, or 7 inlets
Inlet B	1, 2, or 7 inlets
Sample inlet	0, 1, or 7 inlets
Additional inlets	Up to 16

### UV monitors

	UV monitor U9-L	UV monitor U9-M
Wavelength range	280 nm	190 to 700 nm in steps of 1 nm, up to three simultaneous wavelengths
Flow cells	Standard: Optical path length 2 mm Cell volume 2 µL Options: Optical path length 5 mm Cell volume 6 µL	Standard: Optical path length 2 mm Cell volume 2 µL Options: Optical path length 10 mm Cell volume 8 µL Optical path length 0.5 mm Cell volume 1 µL Optical path length 2 mm Cell volume 0.8 µL (only for ÄKTA™ pure micro)
Resolution	0.001 mAU	0.001 mAU
Linearity	± 5% within 0–2 AU	± 2% within 0–2 AU
Drift	≤ 0.2 mAU; AU/h, 2 mm cell	≤ 0.2 mAU; AU/h at 280 nm, 2 mm cell
Noise	< 0.1 mAU	< 0.08 mAU
Lamp operating time	> 10 000 h	> 5000 h

### Conductivity monitor, C9n and C9-M

Conductivity reading range	0.01 mS/cm to 999.99 mS/cm
Accuracy	± 0.01 mS/cm or ± 2%, whichever is greater (within 0.3 to 300 mS/cm)
Operating pressure	0 to 5 MPa
Flow cell volume	Standard: 22 µL ÄKTA™ pure micro (C9-M): 5.4 µL
Temperature monitor range	0°C to 99°C
Temperature monitor accuracy	± 1.5°C within 4°C to 45°C

### Temperature monitor

Reading range	0°C to 99°C
Accuracy	± 1.5°C within 4°C and 45°C

### pH monitor, V9-pH

pH reading range	0 to 14
Accuracy	± 0.1 pH unit within pH 2 to 12
Operating pressure	0 to 0.5 MPa
Flow cell volume	ÄKTA™ pure 25: 76 µL ÄKTA™ pure 150: 129 µL

### Round fraction collector, F9-R\*

Number of F9-R	Up to 2 (two Round fraction collector F9-R or one F9-R and one Flexible fraction collector, F9-C)
Number of fractions	Up to 175 per fraction collector
Vessels	175 (3 mL tubes) 85 (8 or 15 mL tubes) 40 (50 mL tubes)
Fraction volumes	0.1 to 50 mL

Spillage-free mode	DropSync
Flammable liquids	Yes
Dimensions (W × H × D)	320 × 250 × 400 mm
Weight	5 kg
Delay volume (UV – dispenser head) <sup>†</sup>	ÄKTA™ pure 25: 205 µL (86 µL with optional tubing kit, i.d. 0.25 mm) ÄKTA™ pure 150: 473 µL (278 µL with optional tubing kit, i.d. 0.5 mm) ÄKTA™ pure 25 M with Micro kit: 18 µL (with red tubing kit, i.d. 0.13 mm)

### Dual plate fraction collector, F9-T

Number of fraction collectors	1 (if needed add one round fraction collector, F9-R)
Plates	2 (24, 48, 96 deep-well, or 96-well microplates)
Tubes	96 (0.5 mL tubes) 48 (1.5 mL tubes) 48 (2.0 mL tubes) 4 (50 mL tubes)
Fraction volumes	0.02 to 50 mL
Spillage-free mode	DropSync
Dimensions (W × H × D)	320 × 190 × 270 mm
Weight	4 kg
Delay volume	215 µL with standard tubing

### Flexible fraction collector, F9-C<sup>‡</sup>

Number of F9-C	1 (if needed add one Round fraction collector, F9-R)
Number of fractions	Up to 576
Number of cassettes <sup>§</sup>	6
Number of cassette trays <sup>§</sup>	1
Vessel types	Tubes per cassette: 40 (3 mL tubes), total per tray 240 24 (8 mL tubes), total per tray 144 15 (15 mL tubes), total per tray 90 6 (50 mL tubes), total per tray 36 Plates per cassette: 1 deep-well plate (24, 48 or 96 wells), 6 plates per tray Tubes per cassette tray: 55 (50 mL tubes) Bottles per cassette tray: 18 (250 mL bottles of squared shape)
Fraction volumes	0.1 to 250 mL
Spillage-free mode	DropSync, accumulator, or automatic
Flammable liquids	No
Dimensions (W × H × D)	390 × 320 × 585 mm
Weight	21 kg
Delay volume (UV – dispenser head) <sup>†</sup>	ÄKTA™ pure 25: 435 µL (214 µL with optional tubing kit, i.d. 0.25 mm) ÄKTA™ pure 150: 876 µL (508 µL with optional tubing kit, i.d. 0.5 mm)

\* Application supported: affinity chromatography, size exclusion chromatography (gel filtration), ion exchange chromatography, hydrophobic interaction chromatography, and reversed phase chromatography.

<sup>†</sup> The delay volume will change if a different tubing length between the system and the fraction collector is used.

<sup>‡</sup> Application supported: affinity chromatography, size exclusion chromatography (gel filtration), ion exchange chromatography, and hydrophobic interaction chromatography.

<sup>§</sup> The fraction collector can hold either up to six cassettes or one cassette tray.

## Outlet valves

Number of outlets	Valve V9-Os or V9H-Os: 3 (waste, fraction collector, 1 outlet position) Valve V9-O or V9H-O: 12 (waste, fraction collector, 10 outlet positions)
Fraction volumes	2 mL to 10 000 mL
Delay volume (UV – outlet valve)	ÄKTA™ pure 25: 125 µL (66 µL with optional tubing kit, i.d. 0.25 mm) ÄKTA™ pure 150: 296 µL (245 µL with optional tubing kit, i.d. 0.5 mm) ÄKTA™ pure micro: 12 µL (i.d. 0.13 mm tubing), 38 µL (i.d. 0.25 mm tubing)

## Air sensors

Number of sensors	Up to 7
Placement of built-in sensors	Inlet valve V9-IA, Inlet valve V9-IB, Sample inlet valve V9-IS
Placement of additional sensors	After the injection valve sensors Before the system pumps Before the sample pump
Sensing principle	Ultrasonic

## I/O-box E9

Number of I/O boxes	2
Number of ports per box	2 analog in, 2 analog out 4 digital in, 4 digital out
Analog range	In ± 2 V Out ± 1 V

## Ordering information

Product	Product code
ÄKTA™ pure 25 L	29018224
ÄKTA™ pure 25 M	29018226
ÄKTA™ pure 25 L1 (V9-IAB, V9-Os)	29018225
ÄKTA™ pure 25 M1 (V9-IAB, V9-Os)	29018227
ÄKTA™ pure 25 M2 (V9-IA, V9-IB, V9-C, V9-O)	29018228
ÄKTA™ pure 150 L	29046665
ÄKTA™ pure 150 M	29046694
ÄKTA™ pure 150 M3 (V9H-IA, V9H-C, V9H-O)	29046697
ÄKTA™ pure micro	29302479
ÄKTA™ pure User Manual, printed copy (digital included)	29282726
Micro kit for ÄKTA™ pure 25 M	29302910
UNICORN™ 7 Workstation license	29128116
UNICORN™ 7 remote license without DVD	29115426
UNICORN™ 7 dry license without DVD	29115427
UNICORN™ 7 DoE concurrent license	29115440
UNICORN™ 7 Standalone Evaluation	29115454
UNICORN™ 7 Evaluation Classic	29115456
UNICORN™ 7 Column Logbook lic	29115441
UNICORN™ 7 manual package	29127795

## System modules and accessories

### Mixer

Mixer chamber 0.6 mL	28956186
Mixer chamber 1.4 mL (incl. with all systems)	28956225
Mixer chamber 5 mL (incl. with ÄKTA™ pure 150)	28956246
Mixer chamber 15 mL	28980309
Online filter kit	18102711
O-ring 13.1 × 1.6 mm, high resistance	29011326
O-ring 13.1 × 1.6 mm (for Mixer chamber 0.6, 1.5 and 5 mL)	28953545
O-ring 22.1 × 1.6 mm (for Mixer chamber 15 mL)	28981857

### Valves\*

	Product code	
	ÄKTA™ pure 25	ÄKTA™ pure 150
Sample inlet valve kit	(V9-IS) 29027746	(V9H-IS) 29050943
Inlet valve kit A	(V9-IA) 29012263	(V9H-IA) 29050945
Inlet valve kit B	(V9-IB) 29012370	(V9H-IB) 29050946
Inlet valve kit AB	(V9-IAB) 29011357	(V9H-IAB) 29089652
Inlet valve X1	(V9-X1) 28957227	(V9H-X1) 28979326
Inlet valve X2	(V9-X2) 28957234	(V9H-X2) 28979328
Mixer valve kit	(V9-M) 29011354	(V9H-M) 29090692
Loop valve kit	(V9-L) 29011358	(V9H-L) 29090689
Column valve	(V9-Cs) 29011355	(V9H-Cs) 29090693
Column selection valve	(V9-C) 29011367	(V9H-C) 29050951
Column selection valve, second	(V9-C2) 28957236	(V9H-C2) 28979330
pH valve kit	(V9-pH) 29011359	(V9H-pH) 29051684
Versatile valve	(V9-V) 29011353	(V9H-V) 29090691
Outlet valve kit (10 outlets)	(V9-O) 29012261	(V9H-O) 29050949
Outlet valve kit (1 outlet)	(V9-Os) 29011356	(V9H-Os) 29090694

\* The valves for ÄKTA™ pure 25 and ÄKTA™ pure 150 are compatible with both systems but for optimal performance, the specific valve type should be used.

UV monitor	Product code
Second UV monitor U9-L <sup>†</sup>	29011360
UV flow cell U9-0.5, 0.5 mm for U9-M	28979386
UV flow cell U9-2, 2 mm for U9-M (incl. in system with U9-M)	28979380
UV flow cell U9-10, 10 mm for U9-M	28956378
UV flow cell 2 mm for U9-L (incl. with first UV monitor U9-L)	29011325
UV flow cell 5 mm for U9-L	18112824

Sample pump	Product code
Sample pump S9	29027745
Sample pump S9H	29050593

pH and conductivity monitors	Product code
pH electrode	29387193
O-ring 5.3 × 2.4 mm (for pH electrode)	28956497
Conductivity monitor C9	29011363

Injection valve accessories	Product code
Sample loop 10 µL	18112039
Sample loop 100 µL	18111398
Sample loop 500 µL (incl. with all systems)	18111399
Sample loop 1 mL	18111401
Sample loop 2 mL	18111402
Sample loop 10 mL	18116124
Superloop™ 10 mL	19758501
Superloop™ 50 mL	18111382
Superloop™ 150 mL	18102385

Fraction collector F9-R	Product code
Fraction collector F9-R	29011362
Tube rack with 175 positions for 12 mm vials, bowl, tube support, holder and guide	19868403
Tube rack with, 95 positions for 10–18 mm vials	18305003
Tube rack with 40 positions for 30 mm vials, bowl, tube support, holder and guide	18112467

Fraction collector, F9-T	Product code
Fraction collector F9-T	29454032
F9-T standard nozzle	29477967
F9-T tubing nozzle	29510082
F9-T micro nozzle	29501534
Tubing guide for nozzle	29507802
Microplate holder F9-T	29476921
Tube rack - 0.5 mL tubes	29491085

Fraction collector F9-C	Product code
Fraction collector F9-C	29027743
Cassette tray, holds up to six cassettes	28954209
Cassette, holds 6 × 50 mL tubes (2-pack)	28956402
Cassette, holds 15 × 15 mL tubes (2-pack)	28956404
Cassette, holds 24 × 8 mL tubes (2-pack)	28956425
Cassette, holds 40 × 3 mL tubes (2-pack)	28956427
Cassette, holds 40 × 5 mL tubes (2-pack)	29133422
Cassette, holds 96-, 48-, or 24- deep-well plate (2-pack)	28954212
Rack, holds 55 × 50 mL tubes	28980319
Rack, holds 18 × 250 mL bottles	28981873

Additional air sensors	Product code
Air sensor L9-1.2 mm <sup>‡</sup>	28956502
Air sensor L9-1.5 mm <sup>§</sup>	28956500
Adapter for air sensor	28956342

Miscellaneous	Product code
I/O-box E9	29011361
Real-time unit	29285868

Barcode labels and scanner	Product code
UniTag (1 sheet with 108 labels)	28956491

Tubing kits	Product code	
	ÄKTA™ pure 25	ÄKTA™ pure 150
Tubing kit i.d. 0.25 mm	29011328	–
Tubing kit i.d. 0.5 mm (std. ÄKTA™ pure 25)	29011327	29051669
Tubing kit i.d. 0.75 mm (std. ÄKTA™ pure 150)	29011329	29048242
Tubing kit i.d. 1.0 mm (incl. ÄKTA™ pure 150)	29032426	29032426
Tubing kit for sample inlet valve (7 inlets)	29035331	29051166
Sample tubing kit for 7 inlets, i.d. 0.75 mm	28957217	28957217
Inlet tubing kit for inlet valve IAB	29011330	29106497
Tubing kit for pH valve, standard	29011331	29051674
Tubing kit for inlet valve A (7 ports)	29011332	29051197
Tubing kit for inlet valve B (7 ports)	29011333	29051189
Tubing kit for outlet fractionation (10 outlets)	29011334	29048611
System and sample pump rinse tubing kit	29011348	29011348
Peak collect tubing	29314678	29315061

Cables	Product code
Jumper D-SUB	29011365
Jumper 1 IEC 1394 (F-type)	28956489
External module cable, short	29012474
External module cable, long	29011366
2.5 m cable for F9-C or S9 (UniNet-9 D-type)	29032425

Holders	Product code
Column holder rod	28956270
Tubing holder spool, for small tubing (o.d. 1/8" and smaller)	28956274
Tubing holder spool, for large inlet tubing (o.d. 3/16") for ÄKTA™ pure 150	29014283
Column and bottle holder o.d. 10–50 mm	28956282
Tubing holder comb	28956286
Flexible column holder for HiScreen™ columns	28956295
Inlet filter holder kit, ÄKTA™	11000407
Column clamp o.d. 10–21 mm	28956319
Multidirectional column clamp	29383530
Adapter for air sensor	28956342
Bottle and airsenser holder*	28956327
Tube holder (5-pack)	28954329
Multipurpose holder	29011349
Rail extension	29011352
Loop holder with 5 × 10 mL sample loops	29011350
Screw lid kit, ÄKTA	11000410
Extension box	29110806

\* To use as an airsenser holder the adapter 28956342 is also needed.

<sup>†</sup> For Second UV monitor U9-L, flow cells are ordered on separate Product code.

<sup>‡</sup> Automatically detects and prevents air from entering columns. Can be attached to system using adapter for air sensor and bottle holder. Uses 1/16 inch connectors.

<sup>§</sup> Automatically detects air in inlet tubing, for example, to pause system if running out of buffer or for complete loading of sample. Can be attached to system using adapter for air sensor and bottle holder. Uses 1/8 inch connectors.

## Related information

	Reference
UNICORN™ 7 software	cytiva.com/UNICORN
Prepacked chromatography columns for ÄKTA™ systems, Selection guide	CY14019-19Feb21-SG
Micro kit for ÄKTA™ pure 25, Instructions for use	29337720
Connect Alias™ autosampler to ÄKTA™ pure, Instructions for use	29040427
ÄKTA™ laboratory-scale chromatography systems, Instrument management, Handbook	CY13989-02Dec20-HB
Design of experiments (DoE) in protein production and purification, Handbook	CY14782-24Jan21-HB

A range of service agreements and validation support offerings are available. Please contact your Cytiva sales or service representative for details.

Visit our Purify app to select chromatography columns and resins, configure ÄKTA™ systems, and find accessories.

Go to [cytiva.com/purify-app](https://cytiva.com/purify-app)

## [cytiva.com/aktapure](https://cytiva.com/aktapure)

Cytiva and the Drop logo are trademarks of Life Sciences IP Holdings Corporation or an affiliate. ÄKTA, BioProcess, Capto, HiLoad, HiPrep, HiScale, HiScreen, HiTrap, MabSelect, RESOURCE, SOURCE, Superdex, Superloop, Tricorn, and UNICORN are trademarks of Global Life Sciences Solutions USA LLC or an affiliate.

Alias is a trademark of Spark Holland BV. Eppendorf is a trademark of Eppendorf AG. Any other third-party trademarks are the property of their respective owners.

© 2020–2021 Cytiva

For local office contact information, visit [cytiva.com/contact](https://cytiva.com/contact)

CY11416-01Jul21-DF

